

- A Display unit
- B Preset unit
- C Filter unit
- D Riga-unit
- E HF-unit Z84
- F Stereodecoder
- G Connector print
- H Control unit
- I LF-unit
- M Pushbutton unit
- N Stabilization unit
- O Connection unit
- P Rectifier unit
- T Stab. unit
- U FM-balun
- V Record-player
- Z AM-iF unit
- AM-iF unit

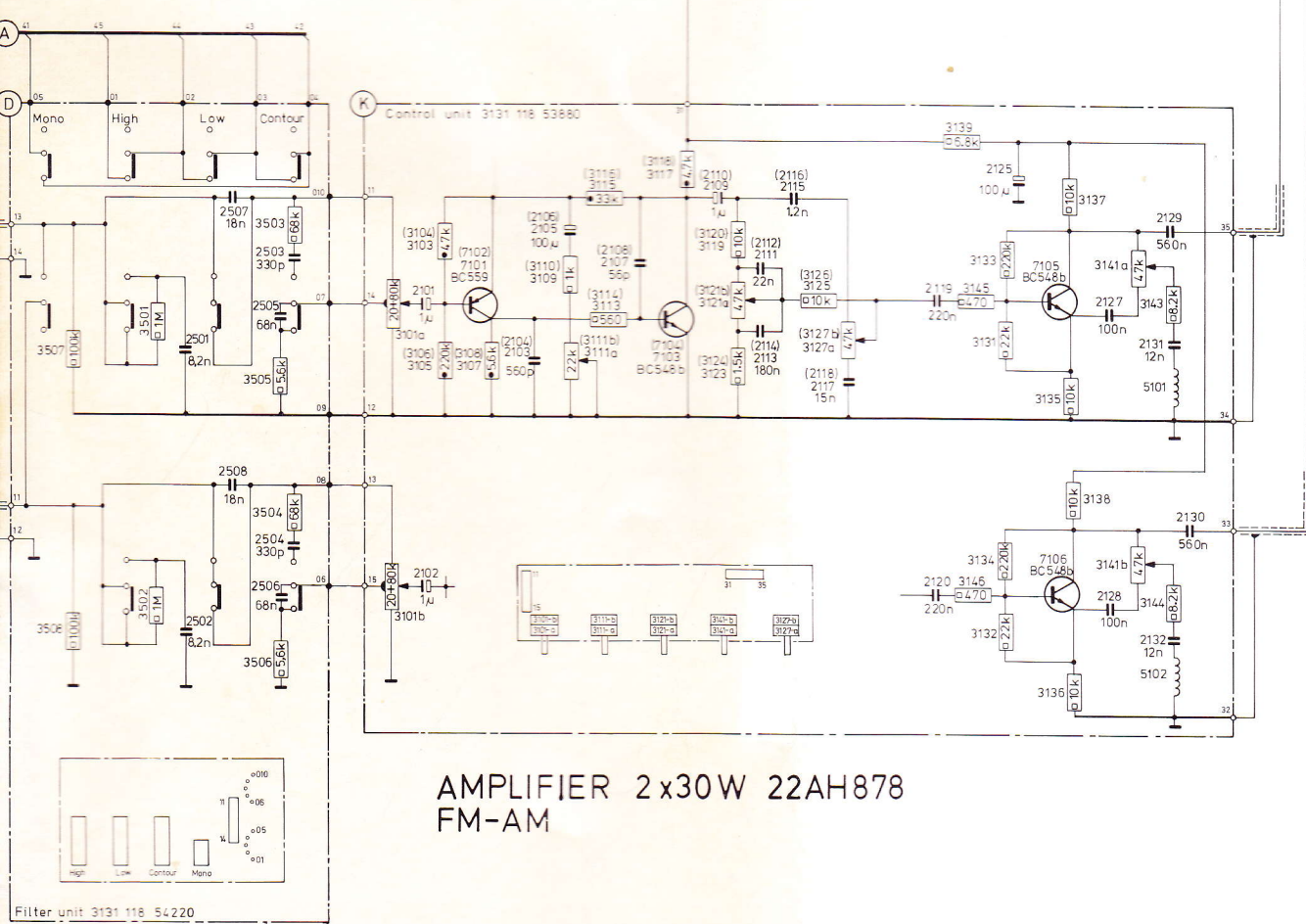

**AMPLIFIER 2x30W 22AH878
FM-AM**

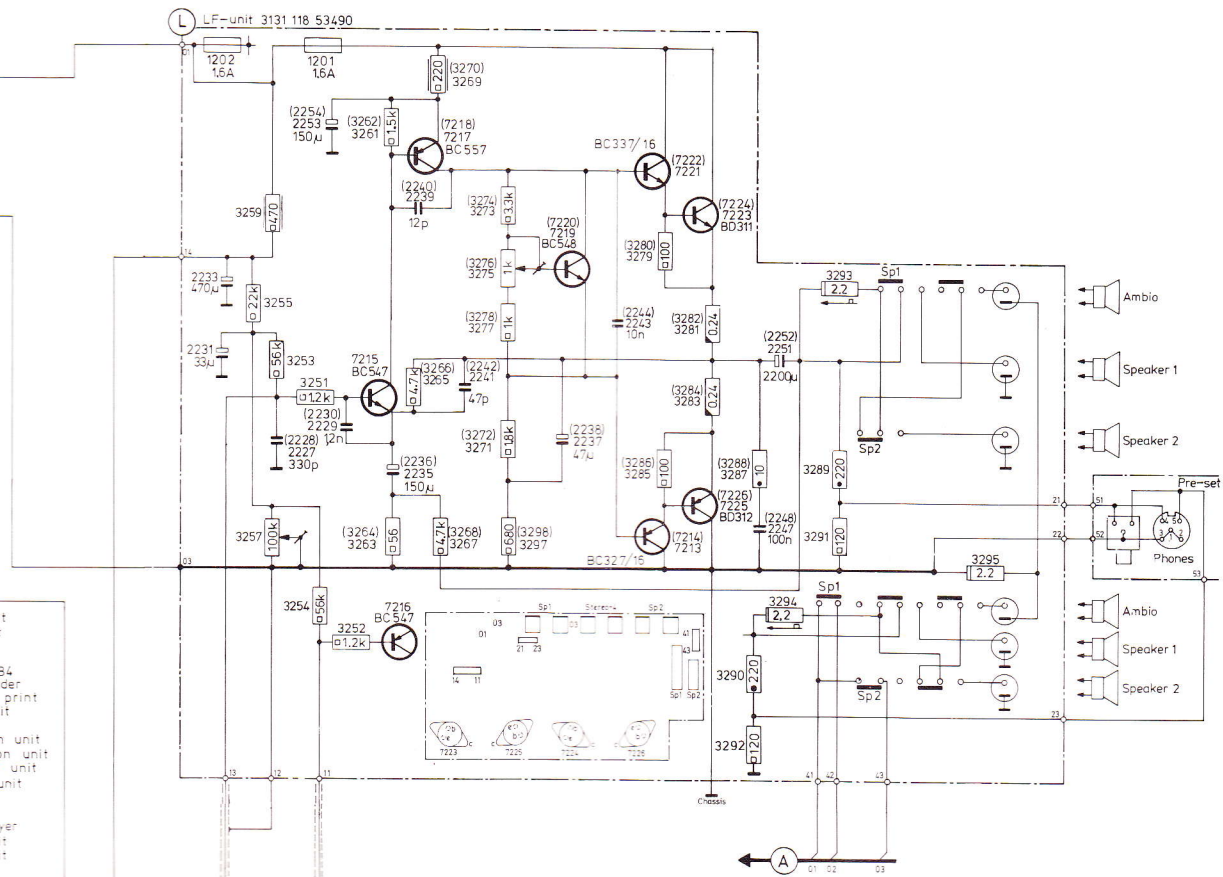
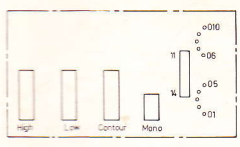

Filter unit 3131 118 54220

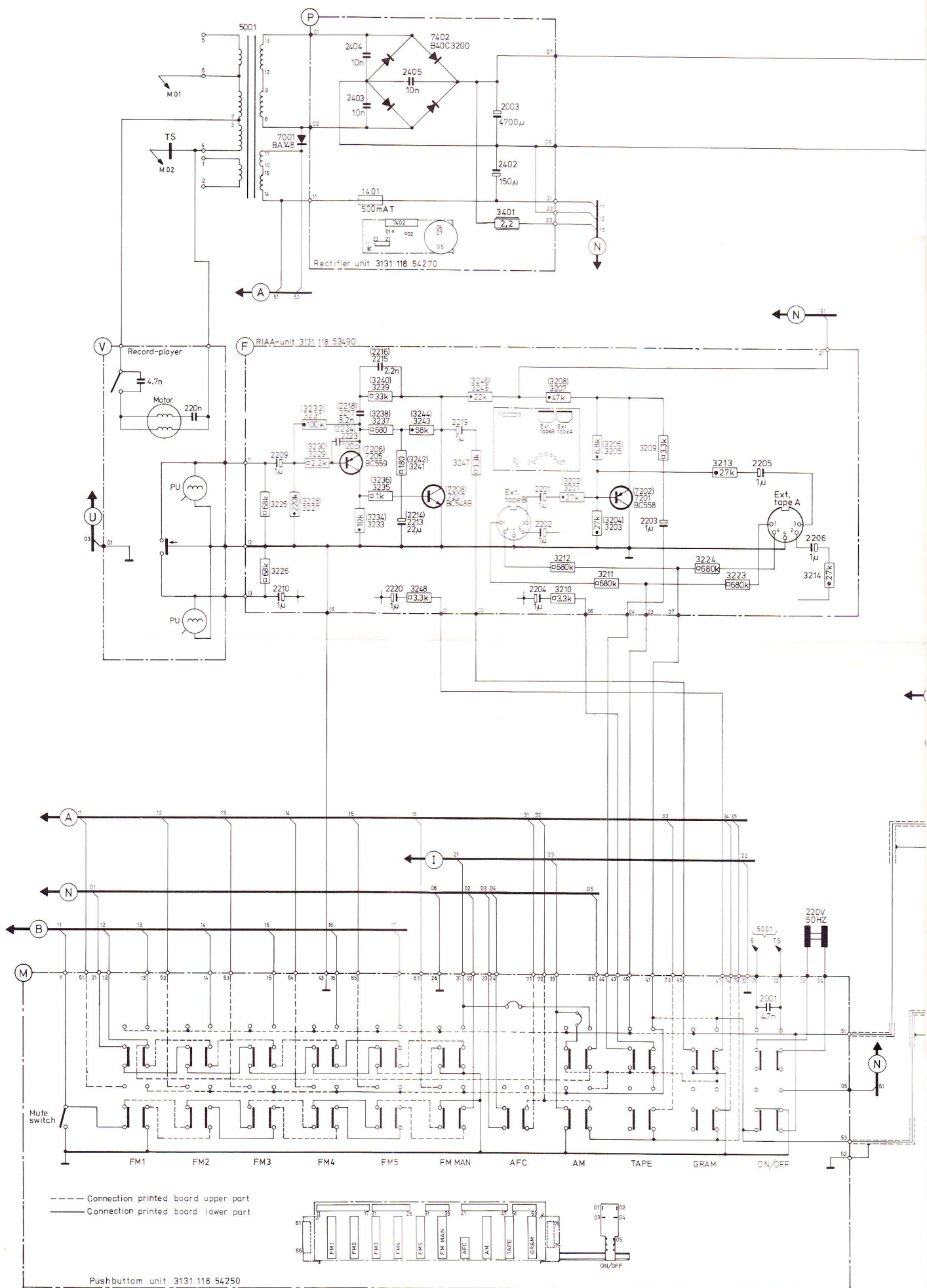

Pushbutton unit 3131 118 54250

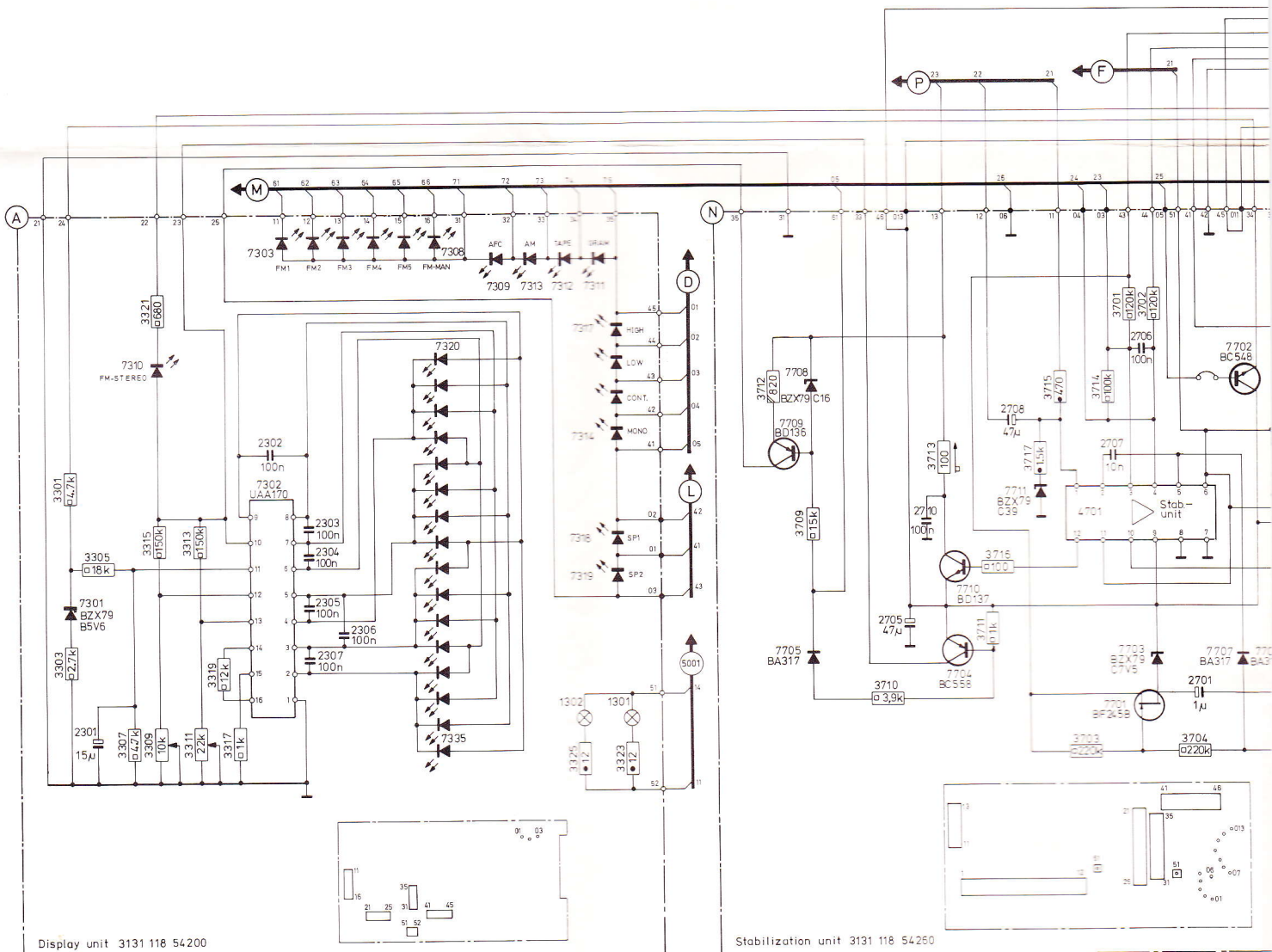
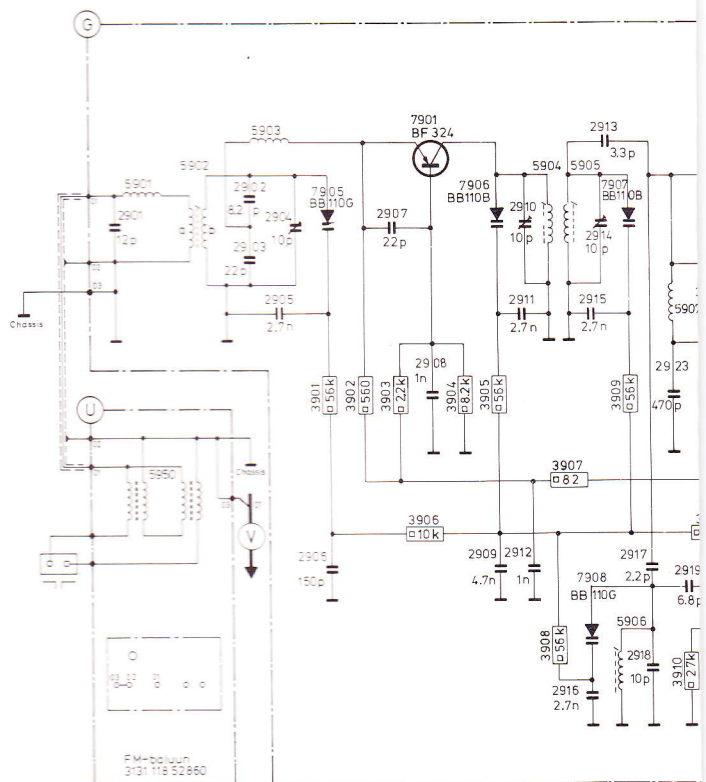
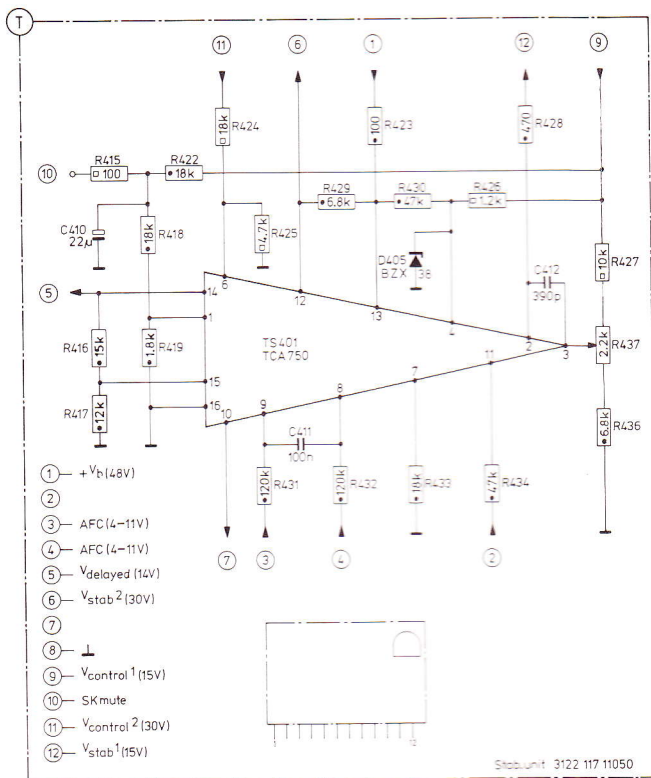

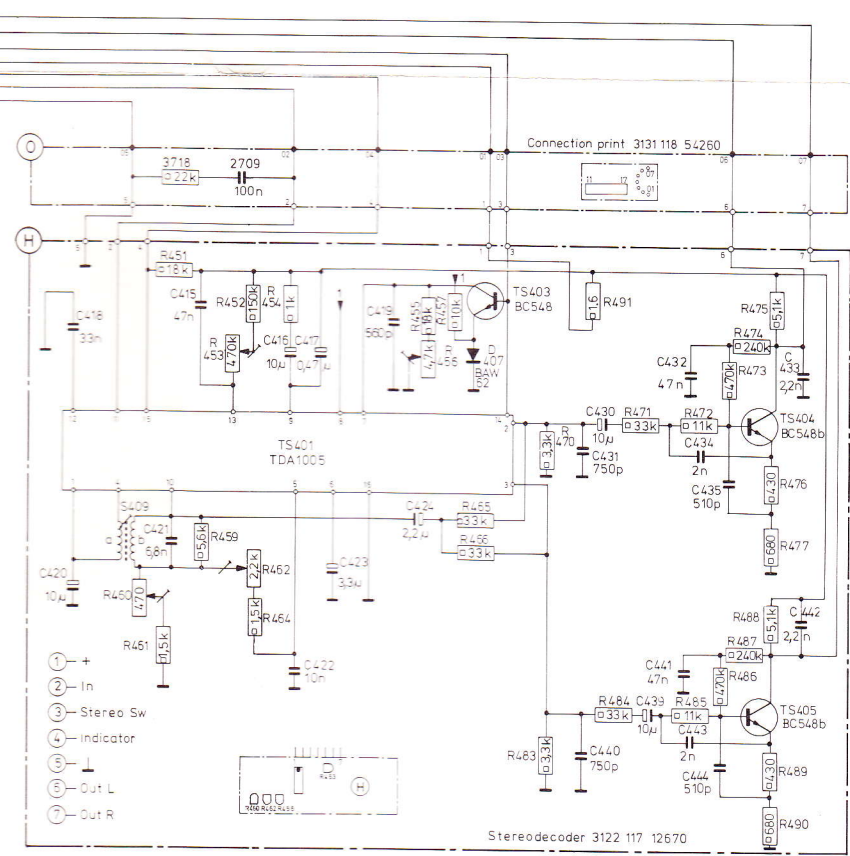
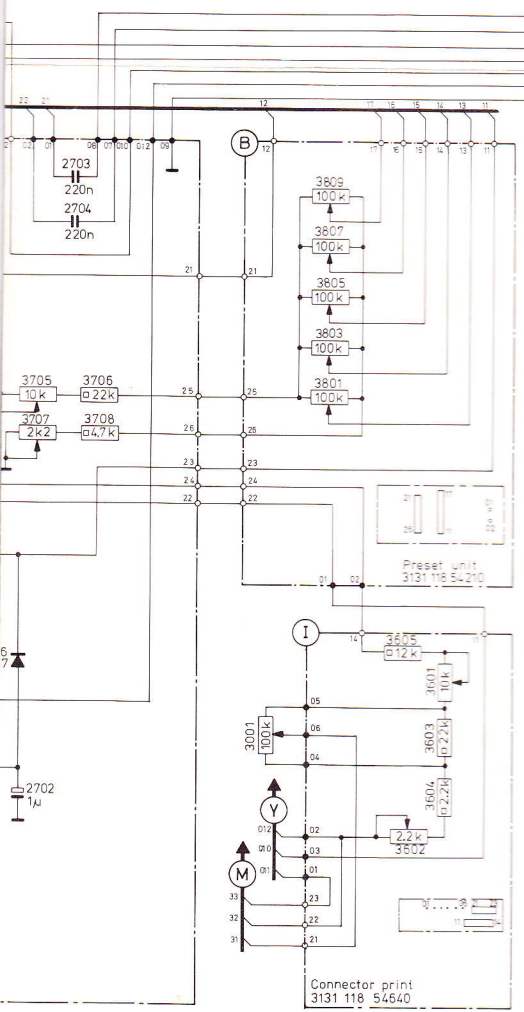
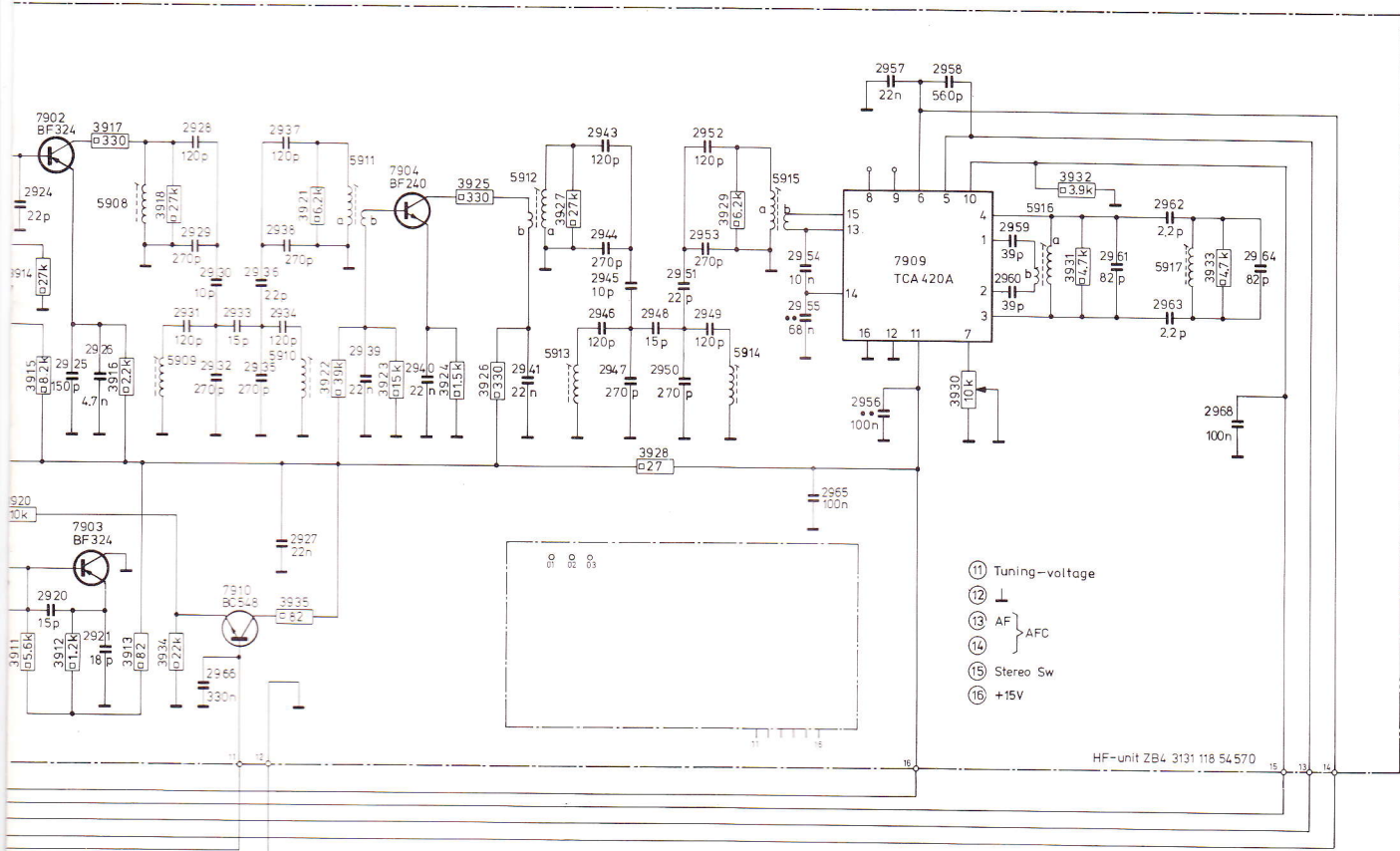

AMPLIFIER 2x30W 22AH878
FM-AM

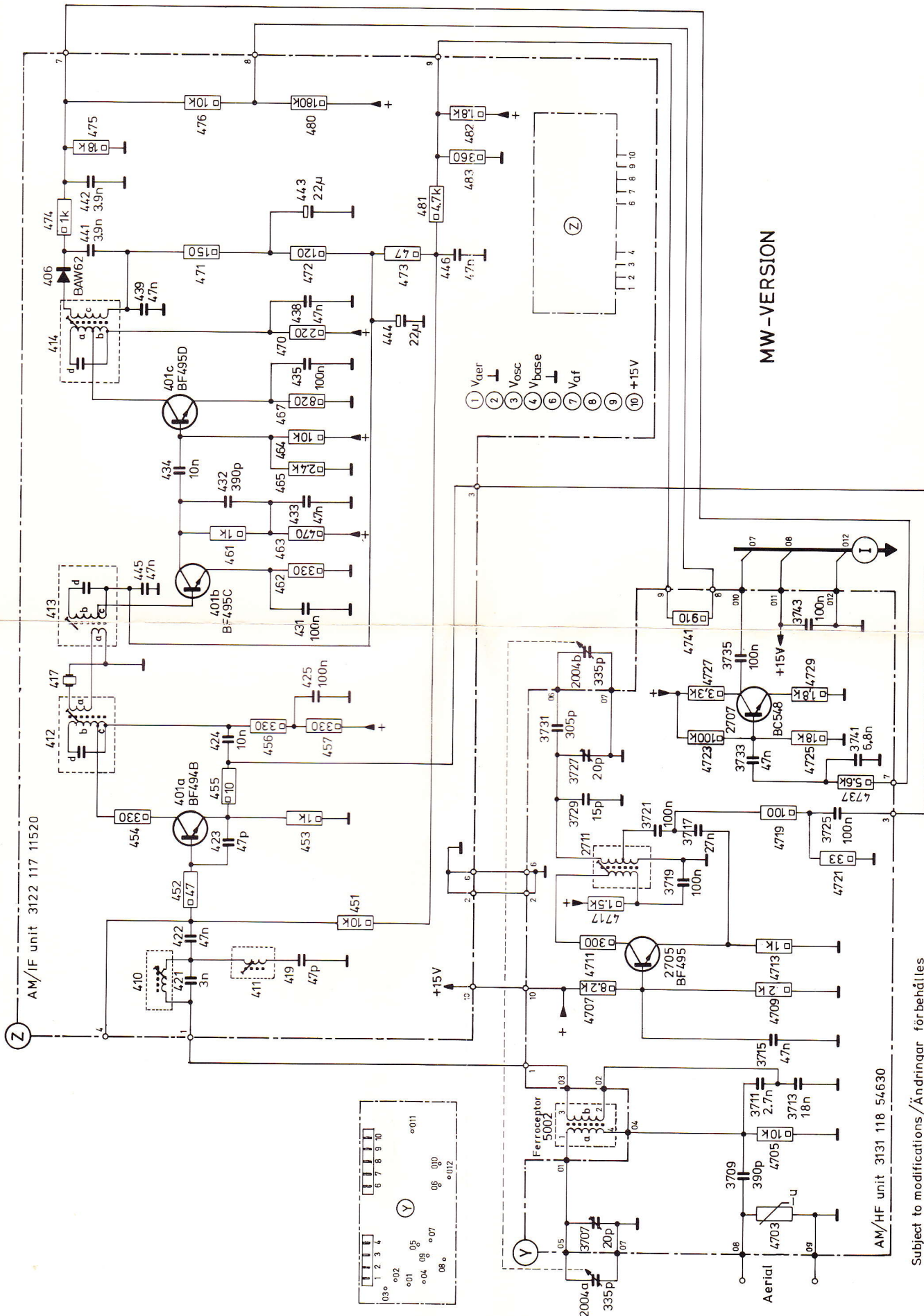

MW-VERSION

AM/IF unit 3122 117 11520

AM/HF unit 3131 118 54630

Subject to modifications/Ändringar förbehålles
3131 136 05430/711

